

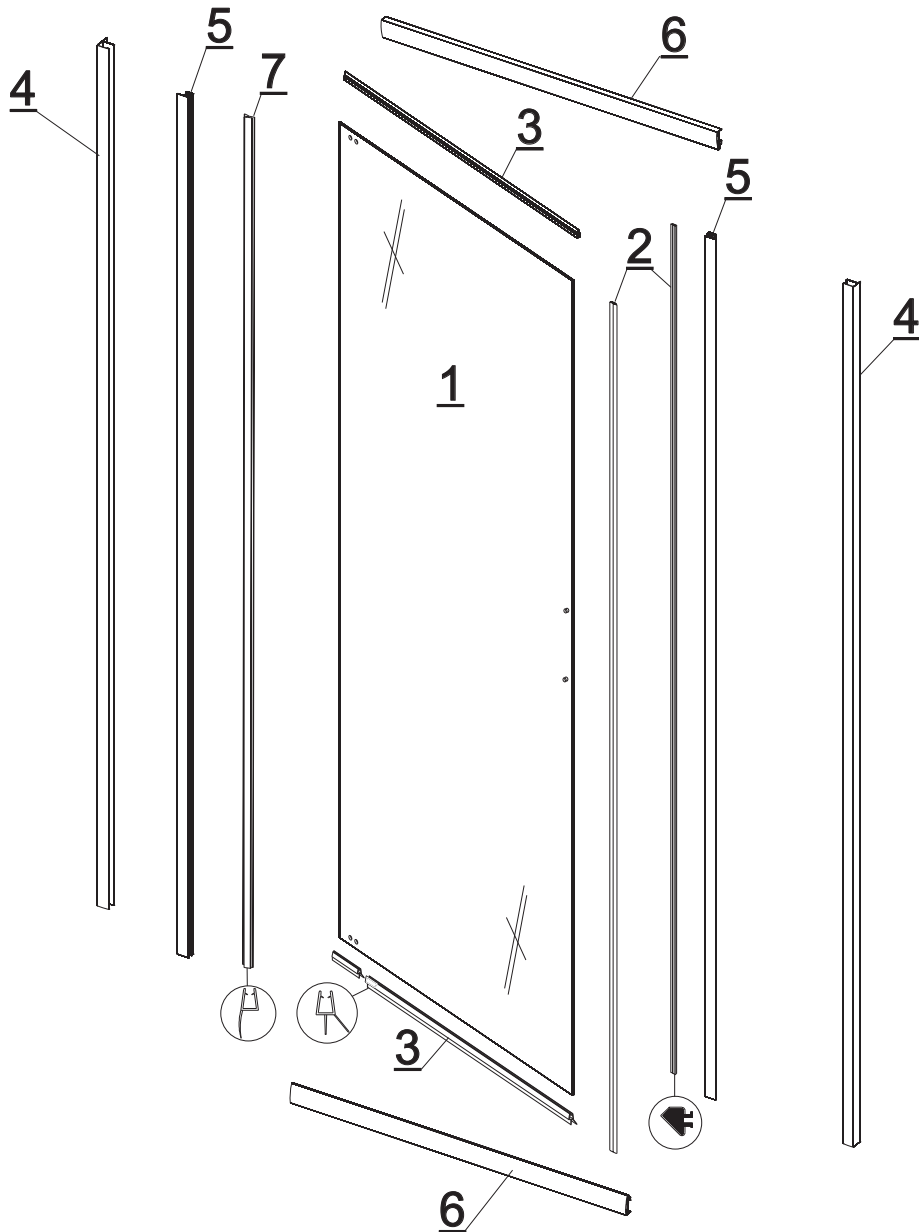







# NIGRA 900x1850

103-092111

SPARE PARTS \* РЕЗЕРВНИ ЧАСТИ \* NÁHRADNI DILI \* ERSATZTEILE \* PIEZAS DE REPUESTO \* VARUSOADE TELLIMISEKS  
 PIECES DE RECHENGE \* A PÓTALKATRÉSZEK \* REZERVNE DIJELOVE \* TAGLIANDO DI COMMISIONE  
 ATSARGINIŲ DALIŲ UŽSAKYMAS \* REZERVES DAĻU PASŪTĪŠANA \* ONDERDELEN \* CZĘŚCI ZAMIENNE \* PIESELOR DE SCHIMB  
 ЗАПАСНЫЕ ЧАСТИ \* BESTÄLLNING AV RESERVDELAR \* OBJEDNÁVKA NÁHRADNÝCH DIELOV \* NAROČILO NADOMESTNIH DELOV  
 ЗАМОВЛЕННЯ НА ЗАПЧАСТИНИ

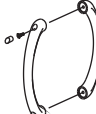

	8	Pieces * Брой Kusú * Stüçk Cantidad * Huk Quantité * Darabszám Komadi * Pezzi Vienetai * Gab. Stucks * Szt. * Bucăți Колчество * Stыck Ks.* Kosov * Штук
	4 x 12	6
	4 x 30	12
	3,5 x 20	6
	φ6	6
		12

	9	Pieces * Брой Kusú * Stüçk Cantidad * Huk Quantité * Darabszám Komadi * Pezzi Vienetai * Gab. Stucks * Szt. * Bucăți Колчество * Stыck Ks.* Kosov * Штук
		1

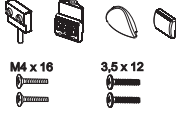
	10	Pieces * Брой Kusú * Stüçk Cantidad * Huk Quantité * Darabszám Komadi * Pezzi Vienetai * Gab. Stucks * Szt. * Bucăți Колчество * Stыck Ks.* Kosov * Штук
	M4 x 16 3,5 x 12	2

№ * Ne * Nr. Nr. * Ne * arv № * Ne * Nr Nr * Nr * Nr. Nr. * Ne * Nr Č. * Št. * Nr	Article No. * № на частта Čís. artiklu * Artikel-Nr No. de artículo * Artikkel arv No. d'article Az alkatrész száma Br dijela * Articolo n. Dadies Nr. * Daļu Nr. Nr. onderdeel. * Nr części Nr. piesei Номенклатурный номер Artikelnummer * Č. dielu Št. artikla * Nr частини	Pieces * Брой Kusú * Stüçk Cantidad * Huk Quantité * Darabszám Komadi * Pezzi Vienetai * Gab. Stucks * Szt. * Bucăți Колчество * Stыck Ks.* Kosov * Штук
1	600-092111-DW	1
2	600-19007-185-DW	1
3	600-19001-90	2
4	600-19002-185-DW	1
5	600-19022	1
6	600-19010-90-DW	2
7	600-19011-185-DW	1
8	600-19005-DW	1
9	600-19006-DW	1
10	600-19008-DW	1